

Data sheet | Item number: 2091-1110/002-1000

1-conductor female plug; Gripping plate sliding connector release; direct marking; 1.5 mm²; Pin spacing 3.5 mm; 10-pole; 1,50 mm²; light gray

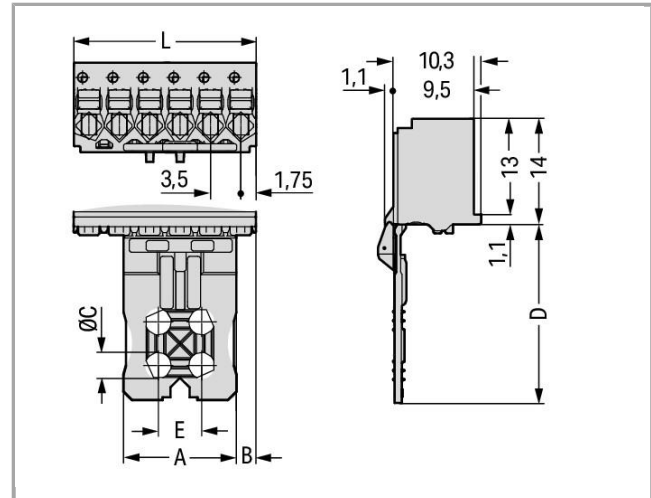

2091-1110_002-1000



Item description

- Universal connection of all conductor types
- Simple, push-in termination of solid and ferruled conductors
- Easy-to-use design does not require special tools
- Ability to wire while mated or unmated
- Testing parallel to conductor entry – tip contact
- Also available with gripping plates
- Integrated locking latches prevent accidental disconnection

Safety information 1:



The **picoMAX[®] pluggable connection system** is designed without breaking capacity for compliance with DIN EN 61984. When used as intended, MCS Connectors shall not be connected/disconnected when live or under load. The circuit design should ensure header pins, which can be touched, are not live when unmated.

Data

Electrical data

Ratings per IEC/EN 60664-1

Rated voltage (III / 3)	160 V
Rated impulse voltage (III / 3)	2.5 kV
Rated voltage (III / 2)	160 V
Rated impulse voltage (III / 2)	2.5 kV
Rated voltage (II / 2)	320 V
Rated impulse voltage (II / 2)	2.5 kV
Rated current	10 A

Approvals per UL 1059

Rated voltage UL (Use Group B)	300 V
Rated current UL (Use Group B)	10 A
Rated voltage UL (Use Group D)	300 V

Connection data

Connection technology	Push-in CAGE CLAMP [®]
Actuation type	Push-button
Solid conductor	0.2 1.5 mm ² / 24 14 AWG
Fine-stranded conductor	0.2 1.5 mm ² / 24 14 AWG
Fine-stranded conductor with ferrule with plastic collar	0.25 0.75 mm ²
Fine-stranded conductor with ferrule without plastic collar	0.25 1.5 mm ²
Strip length	8 9 mm / 0.31 0.35 inch
Total number of connection points	10
Total number of potentials	10
Number of connection types	1
Number of levels	1
No. of poles	10

Geometrical Data

Pin spacing	3.5 mm / 0.138 inch
Width	35 mm / 1.378 inch
Height	39 mm / 1.535 inch
Depth	12.4 mm / 0.488 inch

Mechanical data

Design	With gripping plate and sliding connector release
--------	---

Plug connection

Contact type (pluggable connector)	Female connector/socket
Connector connection type	for conductors
Mismating protection	No

Material Data

Color	light gray
Material group	I
Insulating material	Polyphthalamide (PPA GF)
Flammability class per UL94	V0
Clamping spring material	Chrome nickel spring steel (CrNi)
Contact material	Electrolytic copper (E _{Cu})
Contact plating	tin-plated
Fire load	0.13 MJ
Weight	5.23 g

Environmental Requirements

Limit temperature range	-60 +100 °C
-------------------------	-------------

Commercial data

Country of origin	DE
GTIN	4050821487227
Customs Tariff No.	85366990990



Approvals / Certificates

Radio-Approvals



Logo	Approval	Additional Approval Text	Certificate name
	CB DEKRA Certification B.V.	IEC 61984	NL-49736
	KEMA/KEUR DEKRA Certification B.V.	EN 61984	71- 102260

Country specific Approvals

Certificate

Logo	Approval	Additional Approval Text	name
	CB DEKRA Certification B.V.	IEC 61984	NL-49736
	CSA DEKRA Certification B.V.	C22.2	2362521
	KEMA/KEUR DEKRA Certification B.V.	EN 61984	71- 102260

Other Approvals

Logo	Approval	Additional Approval Text	Certificate name
	UR Underwriters Laboratories Inc.	UL 1059	E45172
	UR Underwriters Laboratories Inc.	UL 1059	E45172

UL-Approvals

Logo	Approval	Additional Approval Text	Certificate name
	UR Underwriters Laboratories Inc.	UL 1059	E45172

Compatible products

tools

	Item no.: 210-719 Operating tool; Blade: 2.5 x 0.4 mm; with a partially insulated shaft	210-719
--	---	---------

Coding

	Item no.: 2091-1610 Coding key carrier; suitable for 3.5 mm pin spacing; orange	2091-1610
--	---	-----------

check

	Item no.: 735-500 Test pin; 1 mm Ø; with solder connection for test wire	735-500
--	--	---------



Downloads

Documentation

Additional Information

Technical explanations

Apr 3, 2019

pdf
3.6 MB

Download

Product family

picoMAX

Show all products from the family

Subject to changes.
